

# Supplemental Parts

## Reagent Shelving

Reagent Shelving can be added to wall or center assemblies for additional storage space where supporting walls are not available. Reagent shelf supports and fascia panels are furnished in painted steel ... finished in any of our standard colors. All reagent shelf supports are available for wall table use also—they are furnished 8" wide and may be specified by adding "WT" to end of catalog number, i.e.: RS-5-WT

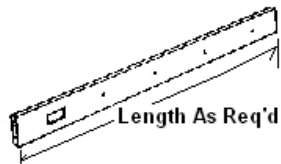

## REAGENT SHELF SUPPORTS FOR USE WITH FASCIA PANELS FOR SERVICES

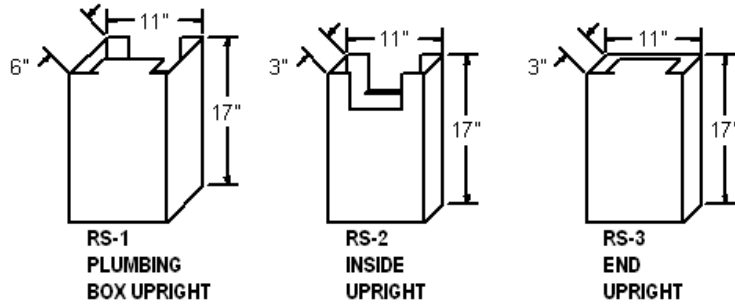

## REAGENT SHELF SUPPORTS FOR SHELVING ONLY

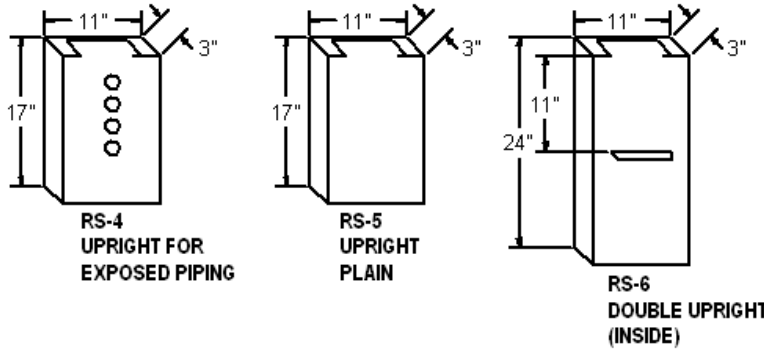

RS-7  
DOUBLE SHELF  
UPRIGHT (OUTSIDE)  
SAME AS RS-6 EXCEPT  
HAS (1) INTERMEDIATE  
ANGLE (CAN BE USED  
LEFT OR RIGHT END)

## Fill Panels & Enclosures

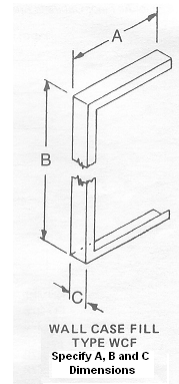
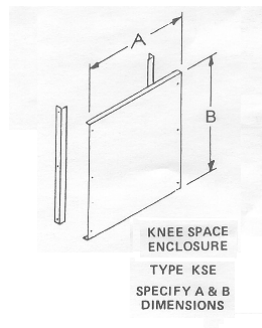
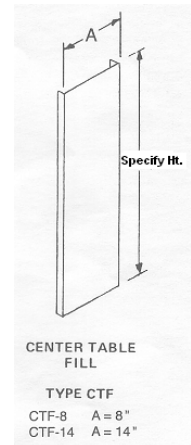
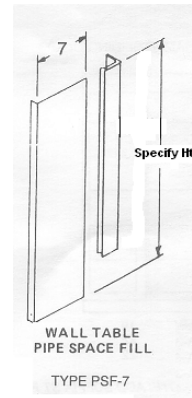
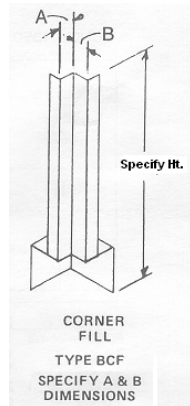
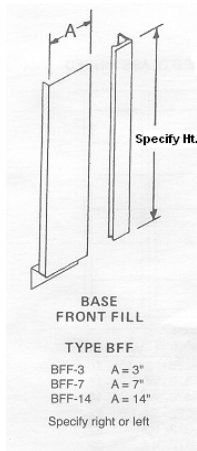

For Base Fill Panels, Specify Standing Height (35 1/4") or Sitting Height (29 1/4")

# Cabinet Accessories



**D-302 Sliding Door Lock**



**D-303 Cupboard Lock**



**D-304 Drawer Lock**



**D-305 Frameless Sliding Glass Door Lock**



**#603 Aluminum Pull**

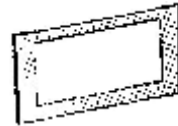

**D-313 Card Holder**



**CC-3S Caster, Swivel locking type for use with cabinetry**

**CC-3F Caster, same as above except fixed type**



**LC-38 Caster, swivel locking type for use with "H" Leg Frames**

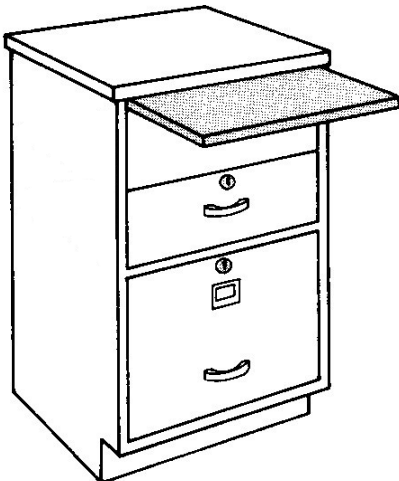

**Pullout shelves are available in top rails of cabinets.**

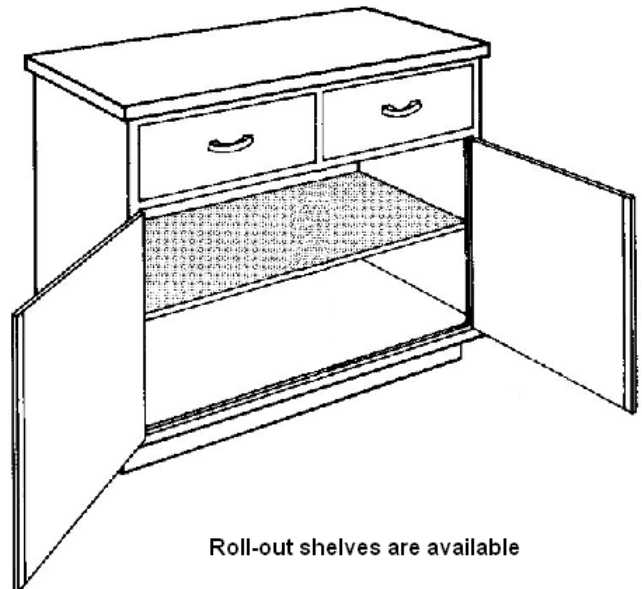

**Roll-out shelves are available**